

# Product Specification Sheet

## LAMERS AIR KNIFE - 6" XE

### CARBON STEEL OR STAINLESS STEEL

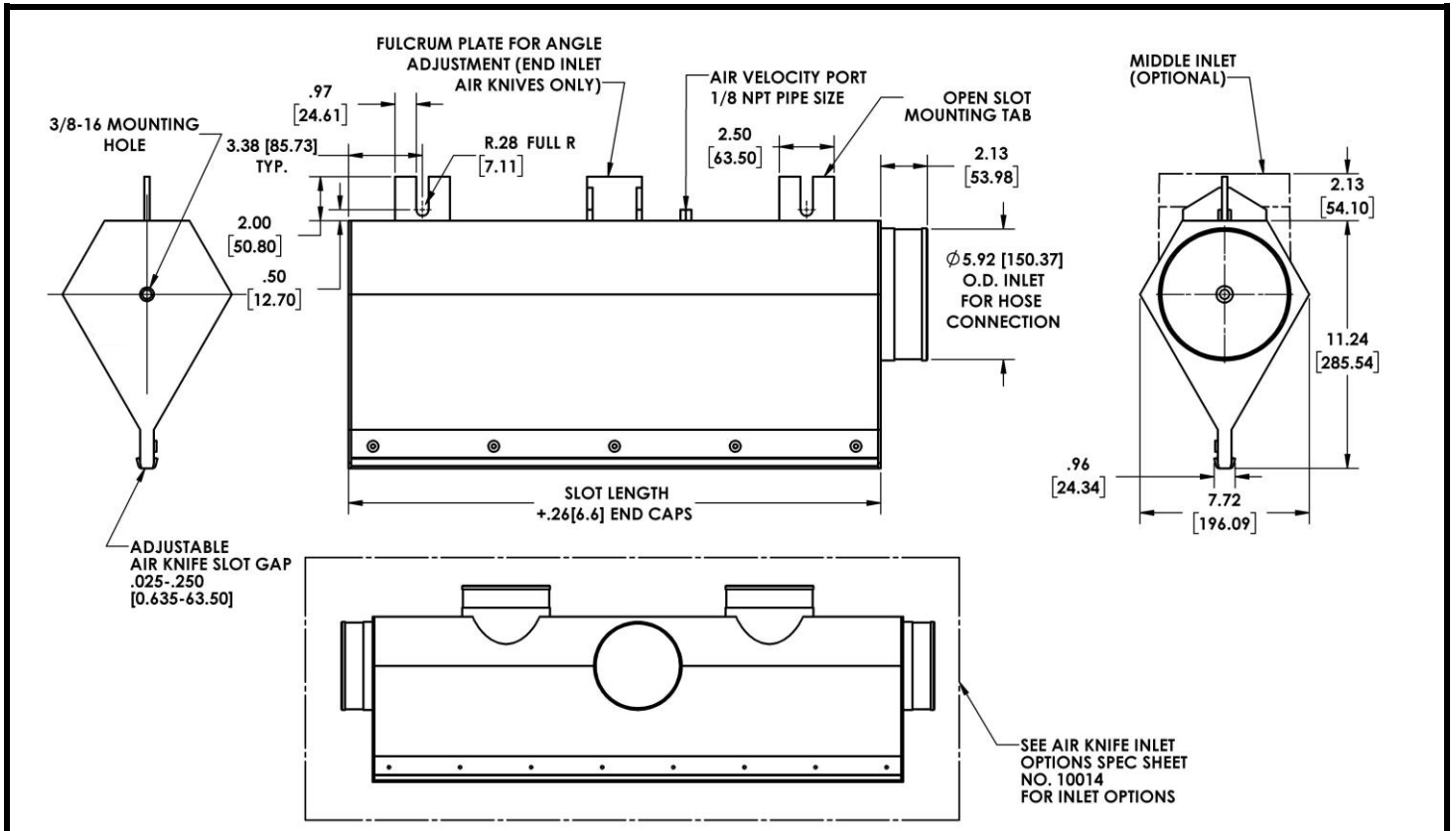

Dimensions in Inches, [ ] are in millimeters

Description	Air Knife 6" Steel	Air Knife 6" S.S.
Part Number	CALL LAMERS	CALL LAMERS
Custom Slot Lengths	12.0 to 120.0in [304,8 to 3048,0 mm]	12.0 to 120.0in [304,8 to 3048,0 mm]
Air Flow Rates	16 cfm/in to 50 cfm/in (297 lps/m to 929 lps/m)	16 cfm/in to 50 cfm/in (297 lps/m to 929 lps/m)
Temperature Range	-40 °F to 400 °F (-40 °C to 204 °C)	800 °F (427 °C)
Material	Body-11 Gauge Carbon Steel Hardware - S.S.	Body-11 Gauge S.S. Hardware - S.S.
Finish	Powder Painted	Electropolish
Weight (Approx.)	12.5 lbs/ft (18.60 g/mm)	12.5 lbs/ft (18.60 g/mm)